

**STAINLESS STEEL WELDED
TUBE PRODUCTION**
***HERSTELLUNG VON GESCHWEISSTEN
EDELSTAHLROHREN***

ABOUT US

STS Boru was established in Gebze, Turkey in 2015 to produce welded stainless steel pipes. We have developed ourselves to meet the evolving needs of the industry. We have become the leading manufacturer in Turkey with an annual production capacity of 6,000,000 m.

We produce solutions for your requests regarding surface quality, suitability for pipe forming and special diameters.

Our target is to be the first stainless steel pipe and profile manufacturer that comes to mind in the sector.

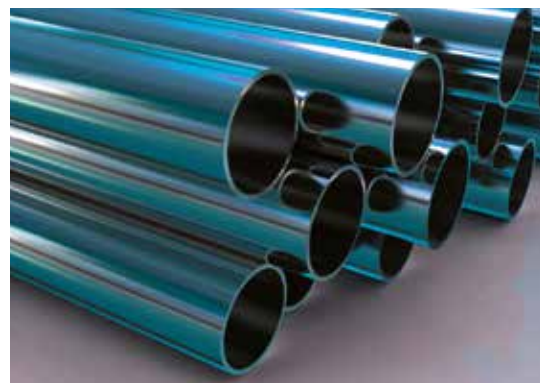

ÜBER UNS

STS Boru wurde 2015 in Gebze, Türkei gegründet, um geschweißte Edelstahlrohre zu produzieren.

Durch Anpassung an die sich entwickelnden Bedürfnisse der Branche sind wir der führende Hersteller in der Türkei mit einer jährlichen Produktionskapazität von 6.000.000 m.

Wir produzieren Lösungen für Ihre Anforderungen bezüglich Oberflächengüte, Eignung zur Rohrumformung und Sonderdurchmesser.

Außerdem machen wir einen festen Schritt, um der erste Edelstahlrohr und Profilhersteller zu werden, der einem in der Branche in den Sinn kommt.

STAINLESS STEEL WELDED TUBE PRODUCTION HERSTELLUNG VON GESCHWEISSTEN EDELSTAHLROHREN

Diameter		0,50	0,60	0,70	0,80	1,00	1,20	1,50	2,00	2,50	3,00
8		0,094	0,111	0,128	0,144	0,175	0,204				
10	1/8"	0,119	0,141	0,163	0,184	0,225	0,264	0,319			
12		0,144	0,171	0,198	0,224	0,275	0,325	0,394	0,501		
13		0,157	0,186	0,216	0,244	0,300	0,355	0,432	0,551		
13,5	1/4"	0,163	0,194	0,224	0,254	0,313	0,370	0,451	0,576		
14		0,169	0,201	0,233	0,264	0,326	0,385	0,470	0,601		
15		0,182	0,216	0,251	0,284	0,351	0,415	0,507	0,651		
16		0,194	0,231	0,268	0,304	0,376	0,445	0,545	0,701		
17,2	3/8"	0,209	0,249	0,289	0,329	0,406	0,481	0,590	0,761		
18		0,219	0,261	0,303	0,345	0,426	0,505	0,620	0,801		
19		0,232	0,276	0,321	0,365	0,451	0,535	0,657	0,851		
20		0,244	0,291	0,338	0,385	0,476	0,565	0,695	0,901	1,096	
21,3	1/2"	0,260	0,311	0,361	0,411	0,508	0,604	0,744	0,967	1,177	1,375
22		0,269	0,322	0,373	0,425	0,526	0,625	0,770	1,002	1,221	1,427
25		0,307	0,367	0,426	0,485	0,601	0,715	0,883	1,152	1,409	1,653
26,9	3/4"		0,395	0,459	0,523	0,649	0,772	0,954	1,247	1,527	1,795
28			0,412	0,479	0,545	0,676	0,805	0,995	1,302	1,596	1,878
30			0,442	0,514	0,585	0,726	0,865	1,070	1,402	1,722	2,028
32			0,472	0,549	0,625	0,776	0,925	1,146	1,502	1,847	2,178
33,7	1"			0,578	0,659	0,819	0,977	1,209	1,588	1,953	2,306
35				0,601	0,685	0,851	1,016	1,258	1,653	2,035	2,404
36					0,705	0,876	1,046	1,296	1,703	2,097	2,479
38					0,745	0,926	1,106	1,371	1,803	2,222	2,629
40					0,785	0,977	1,166	1,446	1,903	2,348	2,779
42,4	1.1/4"				0,833	1,037	1,238	1,536	2,023	2,498	2,960
45						1,102	1,316	1,634	2,153	2,661	3,155
48,3	1.1/2"					1,184	1,415	1,758	2,319	2,867	3,403
50,8						1,247	1,490	1,852	2,444	3,024	3,591
60,3	2"					1,485	1,776	2,209	2,920	3,618	4,304
63,5	2.1/2"					1,565	1,872	2,329	3,080	3,819	4,545
76,1	3"					1,881	2,251	2,802	3,711	4,607	5,491



STAINLESS STEEL WELDED PROFILE PRODUCTION HERSTELLUNG VON GESCHWEISSTEN EDELSTAHLPROFILEN

Diameter	0,80	1,00	1,20	1,50	2,00
10X20	0,365	0,451	0,535	0,657	
10X30	0,493	0,611	0,727	0,898	
10X40		0,776	0,925	1,146	
10X50		0,926	1,106	1,371	
20X20	0,493	0,611	0,727	0,898	1,172
20X30	0,625	0,776	0,925	1,146	1,502
20X40		0,926	1,106	1,371	1,803
20X50			1,316	1,634	2,153
30X30	0,745	0,926	1,106	1,371	1,803
30X40	0,885	1,102	1,316	1,634	2,153
30X50		1,247	1,490	1,852	2,444
40X40		1,247	1,490	1,852	2,444
40X60		1,565	1,872	2,329	3,080
50X50			1,872	2,329	3,080
60X60			2,251	2,802	3,711

SPECIAL PROFILES

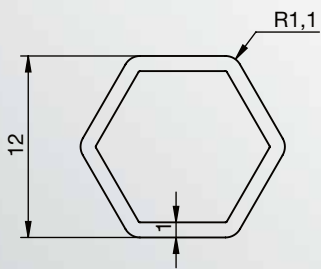

HEXAGON

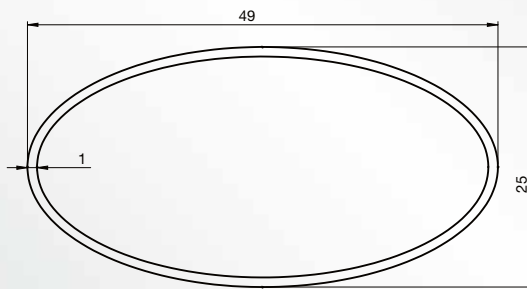

CAT EYE

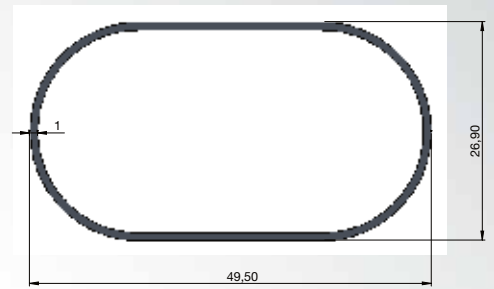

FLAT OVAL

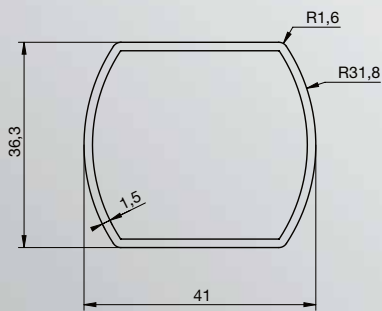

SEMI FLAT OVAL

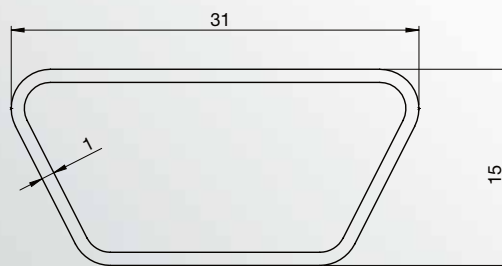

PAN HANDLE

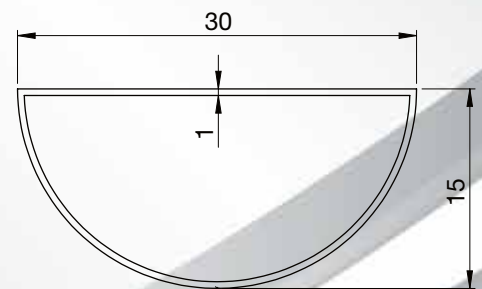

D PROFILE



QUALITY AND PRODUCTION CERTIFICATES QUALITÄTS- UND PRODUKTIONSZERTIFIKATE



PRODUCTION FLOW CHART

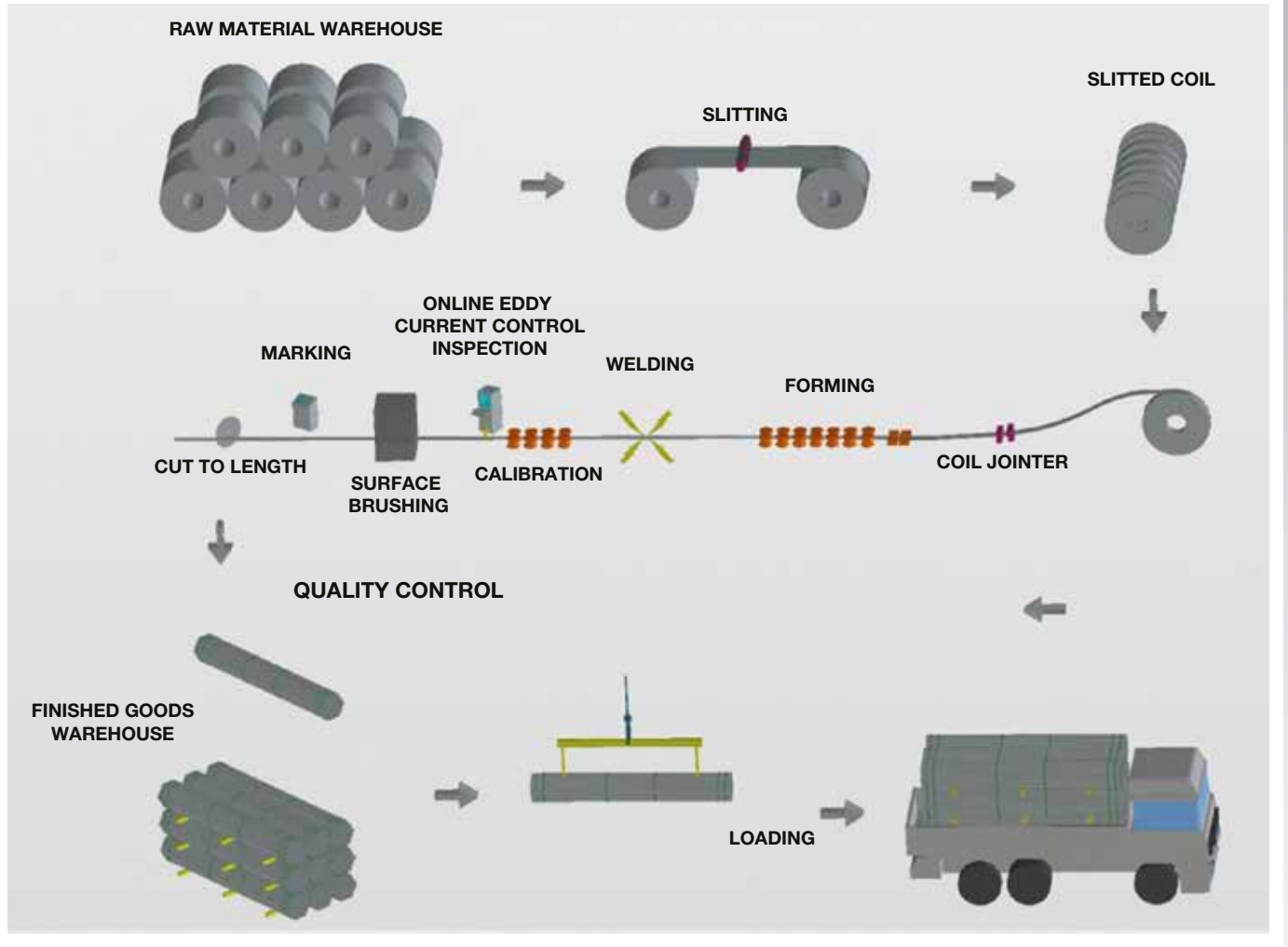

STS PASLANMAZ BORU ÜRETİM
VE PAZARLAMA A.Ş.

Gebze Plastikçiler Org. San. Bölgesi
Cumhuriyet Cad. No:9/A
Gebze - Kocaeli TURKEY
T +90 262 751 50 70
F +90 262 751 50 78